



**KEY FEATURES**

- Available with 30° (Narrow) or 100° (wide) symmetric optics
- Hazardous location available
- Thermally managed for maximum longevity
- Adjustable mounting bracket
- Lifespan up to 100 000 hours
- Available in multiple lengths and with Colored LEDs



**MODEL NUMBER SELECTOR** Example: GSLEDIP36-CW-N-BLK-GEN-12VDC

MODEL	COLOR	OPTIC	FINISH	LOCATION	POWER
GSLEDIP36				GEN	
	<b>CW</b> - Cool White <b>NW</b> - Neutral White <b>WW</b> - Warm White <b>CUS</b> - Custom <i>Contact for custom color</i>	<b>N</b> -Narrow <b>W</b> -Wide <b>NF</b> -Narrow Frosted <b>WF</b> -Wide Frosted	<b>BLK</b> - Black <b>WHT</b> - White <b>CUS</b> -Custom <i>Contact for custom finish</i>	<b>GEN</b> - General <i>C1D2 Available for Hazardous Locations See GSLEDIP-C1D2</i>	<b>12VDC</b> -12 Volts DC <b>24VDC</b> -24 Volts DC

**TECHNICAL SPECIFICATIONS / MAXIMUM RATINGS**

HOUSING	Powder Coated Extruded Aluminum
MOUNTING	Mounting Brackets (Other Options Available See Pg2)
VOLTAGE MAXIMUM	28 VDC
TYPICAL INPUT VOLTAGE	12VDC: 11-16 VDC   24VDC: 22-28 VDC
POWER	25.2 W
CURRENT	1.98 A @12 VDC   0.99 A @ 24 VDC
CONNECTIONS	6Ft Flying Lead (Custom Lengths Available)
TEMPERATURE RANGE	-40°C – +85°C
TYPICAL CASE TEMPERATURE	~15°C Above Ambient Temperature
CERTIFICATIONS	Certified To CSA 22.2 No. 250.0 , Conforms To UL 1598 Standard
INGRESS PROTECTION	IP54
COLOR TEMP RANGE	CW: 6500K   NW: 4300K   WW: 3500K
CRI VALUE	CW: 75   NW: 75   WW: 80
TOTAL LUMENS	1812
TOTAL SCOTOPIC LUMEN	3804
WEIGHT	2.1lb   0.9 kg

**DIMENSIONS**

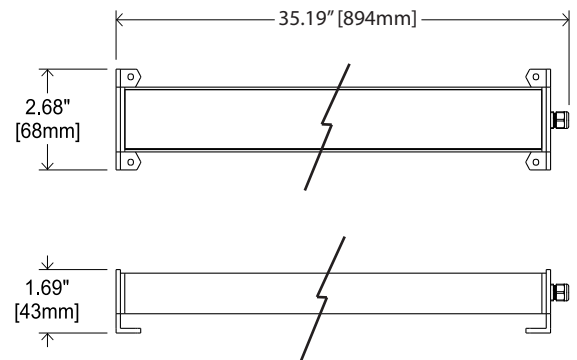

**Alternate Lengths:** (See respective Model Specification Sheets for details)

- GSLEDIP12 13.4" [340mm]
- GSLEDIP24 24.2" [632mm]
- GSLEDIP48 46.9" [1173mm]

PHOTOMETRICS

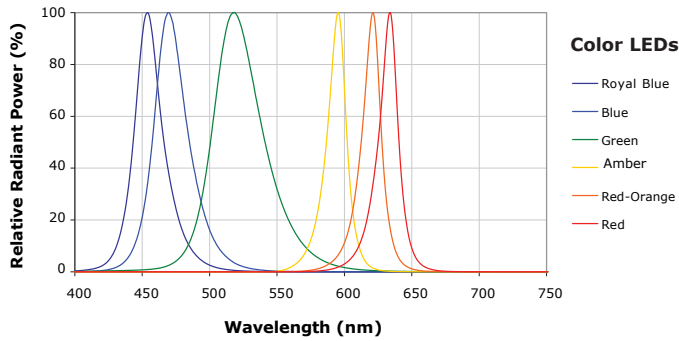
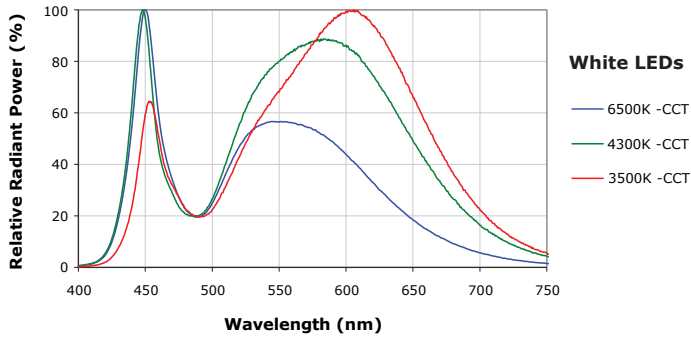

NARROW BEAM



FROSTED LENS



(Shown in White Option)

WIDE BEAM



MOUNTING OPTIONS

MOUNTING BRACKET



(Standard)

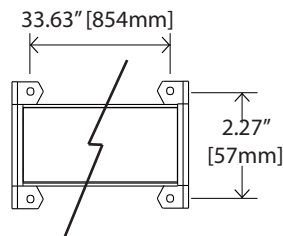

CLIP MOUNT

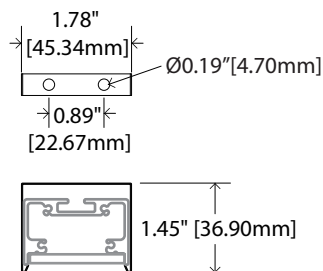

SURFACE MOUNT

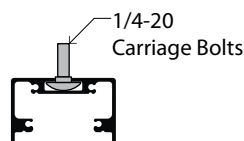

CUSTOM OPTIONS

WIRING SELECTIONS

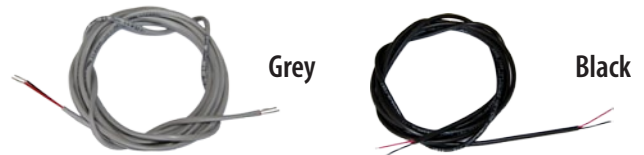

Other wire lengths available in 1 foot increments.

CUSTOM FINISHES

Anodized Aluminum

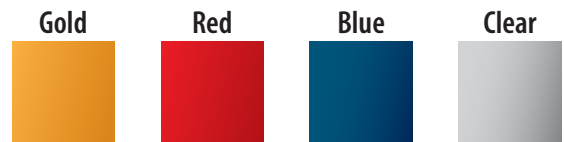

Please contact for further options

Powder Coated Aluminum



Please contact for further options